

--

Datum:
Kund:
Projekt:



131M

Engreppsblandare med keramisk tätning, består av:
 131MUP = Engreppsblandare 100 med fast utlopp.
 131MAP = Grepp NR28M, 250 mm dubbelt svängbar pip 030, 60 mm
 täckbricka 001, 3001.

Handikappanpassad.

Flöde

	Bar:	1,0	2,0	3,0	4,0	5,0
131M	(l/min)	4,8	6,8	8,3	8,3	8,3

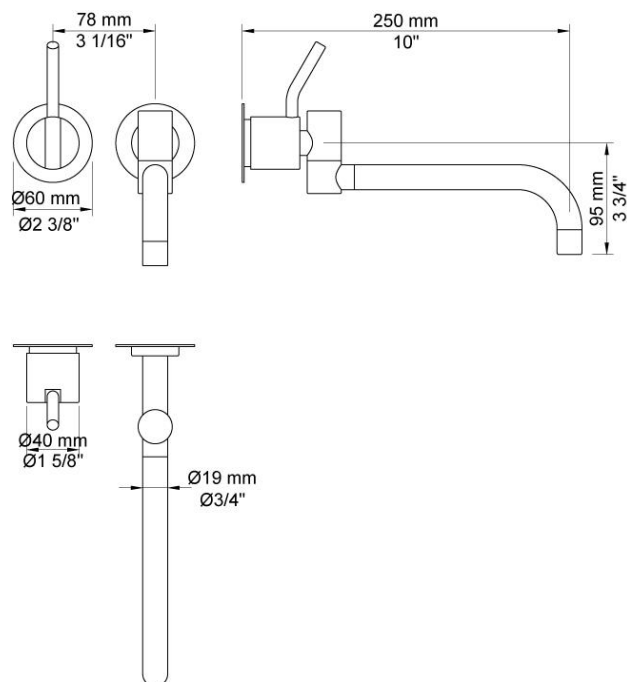
**Levereras i färg**

Färg 02, Grå	Färg 21, Karmosinröd
Färg 04, Blå	Färg 25, Rosa
Färg 08, Gul	Färg 27, Matt-svart
Färg 09, Koksgrå	Färg 28, Matt-vit
Färg 05, Orange	Färg 40, Borstad rostfritt stål
Färg 06, Ljusgrön	Färg 60, Svart
Färg 12, Mocka	Färg 61, Borstad svart
Färg 14, Orangeröd	Färg 62, Djupsvart
Färg 15, Marinblå	Färg 63, Koppar
Färg 16, Krom	Färg 64, Borstad koppar
Färg 17, Glänsande Svart	Färg 65, Guld
Färg 18, Vit	Färg 68, Silver
Färg 19, Mässing natur	Färg 70, Borstad guld
Färg 20, Borstad krom	

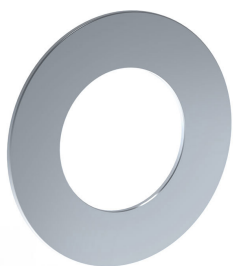

001
60 mm täckbricka.
Innerdiam. 30 mm.

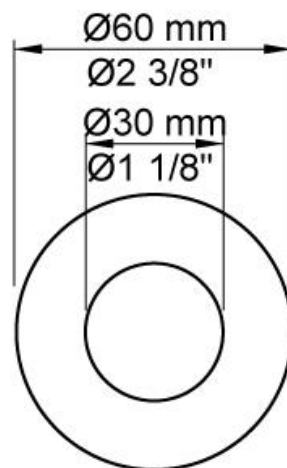

030
250 mm dubbelt svängbar pip.

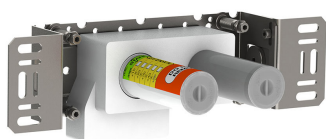
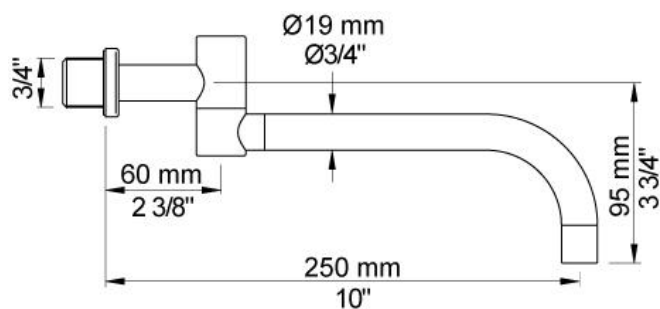

100
Engrepps inbyggnadsblandare med fast utlopp.
För 1/2" CU-rör, pexrör eller stålrör.

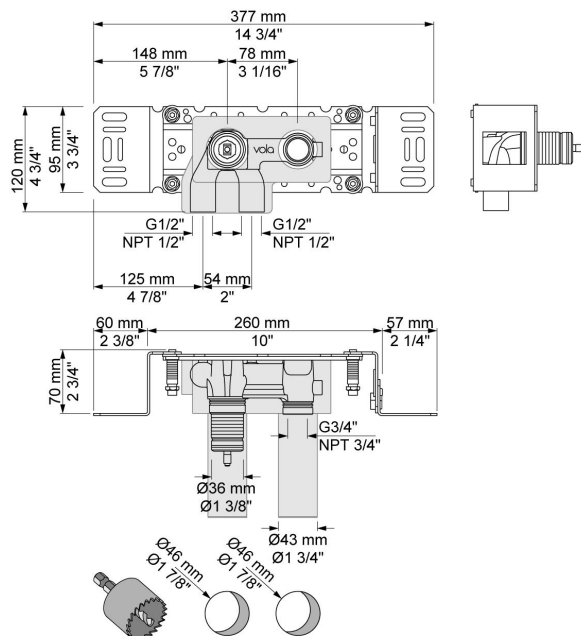

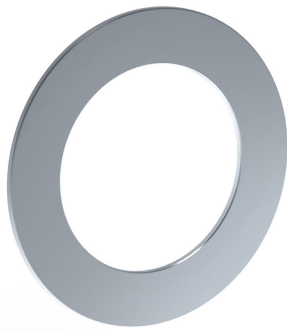
**3001**

60 mm täckbricka.
Innerradi. 36 mm.

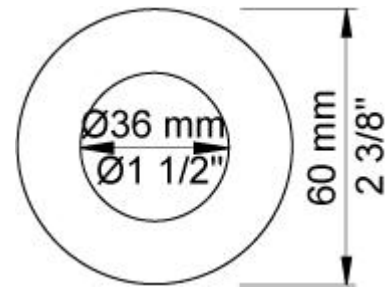
**NR28M**

Medium blandargrepp för 100, 200, 300 och 400. Diameter 40 mm.

