

--

Datum:
Kund:
Projekt:



CE



4921VS

Elektronisk blandare. Sensor integrerad i väggen.

Består av:

4921VSUP = Blandare 4900VS, sensor sladd VR509.

4921VSAP = Grepp NR41, 225 mm fast pip 020, sensor VR510, 60 mm täckbrickor 001, 3001, VR512.

Elektronikbox VR2618 ingår.

Handikappanpassad.

Flöde

	Bar:	1,0	2,0	3,0	4,0	5,0
4921VS ¹⁾	(l/min)	2,9	4,1	5,0	5,0	5,0
4921VS ²⁾	(l/min)	2,6	3,7	4,5	4,5	4,5

¹⁾ USA Standard

²⁾ USA Standard

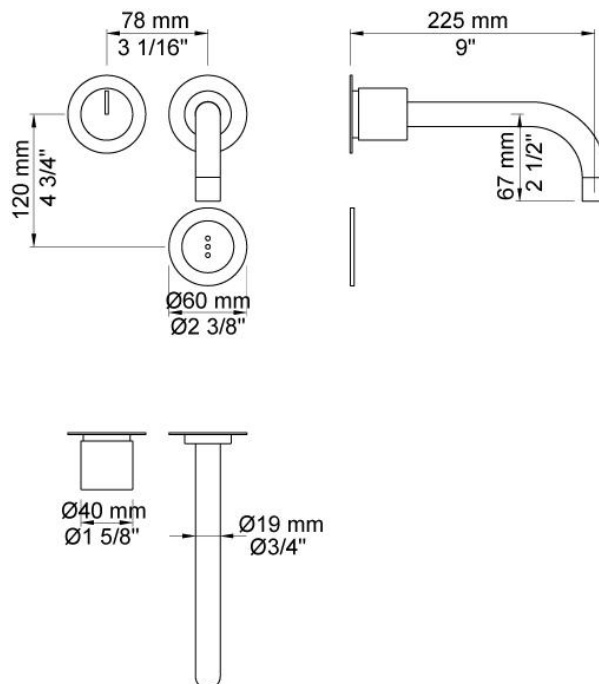
**Levereras i färg**

Färg 02, Grå	Färg 21, Karmosinröd
Färg 04, Blå	Färg 25, Rosa
Färg 08, Gul	Färg 27, Matt-svart
Färg 09, Koksgrå	Färg 28, Matt-vit
Färg 05, Orange	Färg 40, Borstad rostfritt stål
Färg 06, Ljusgrön	Färg 60, Svart
Färg 12, Mocka	Färg 61, Borstad svart
Färg 14, Orangeröd	Färg 62, Djupsvart
Färg 15, Marinblå	Färg 63, Koppar
Färg 16, Krom	Färg 64, Borstad koppar
Färg 17, Glänsande Svart	Färg 65, Guld
Färg 18, Vit	Färg 68, Silver
Färg 19, Mässing natur	Färg 70, Borstad guld
Färg 20, Borstad krom	

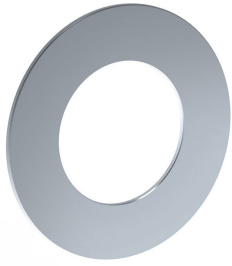
**001**

60 mm täckbricka.
Innerdiam. 30 mm.

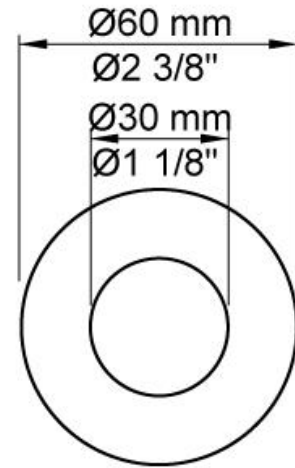
**020**

225 mm fast pip.

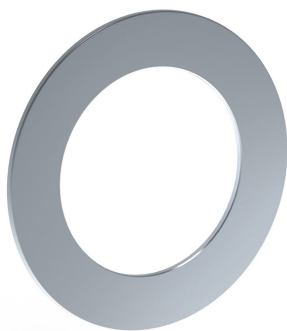
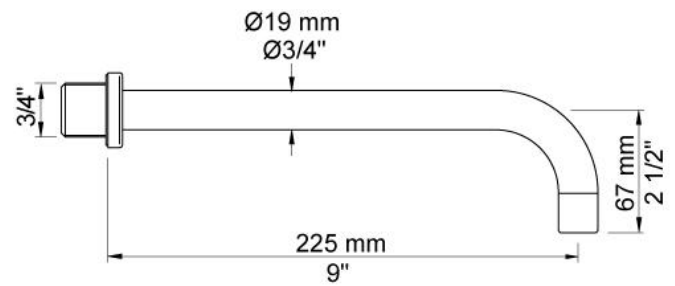
**3001**

60 mm täckbricka.
Innerdiam. 36 mm.

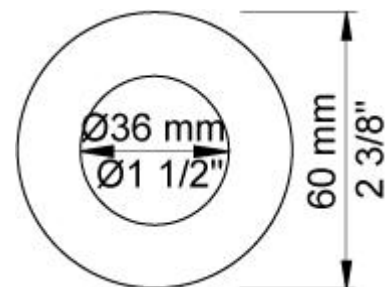

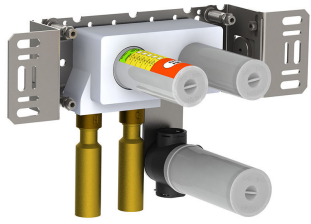

4900VS

Elektronisk inbyggnadsblandare inkl. temperaturreglering.
Elektronikbox VR2618 ingår.

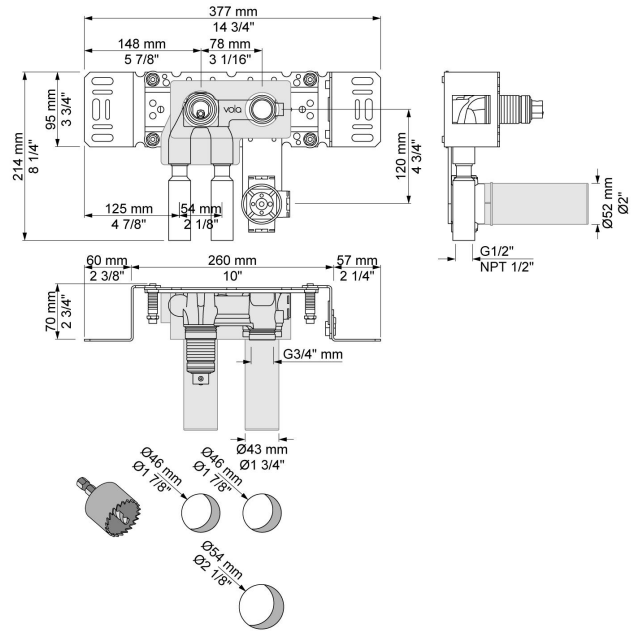

NR41

Grepp för 4900.

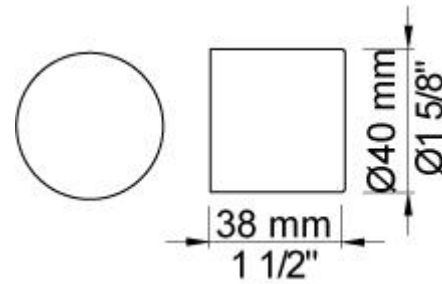

VR2618

Elektronikbox.

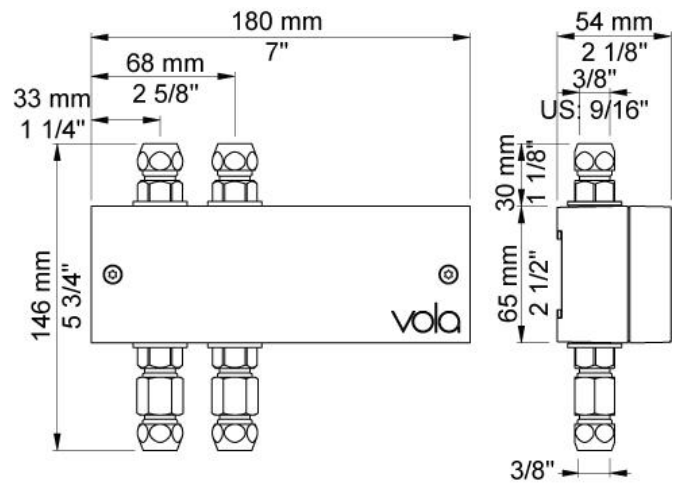

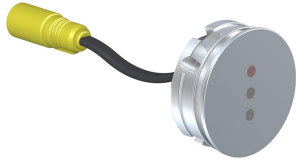
**VR510**

Sensor för 4300, 4800 och 4900.

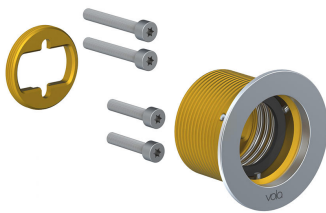
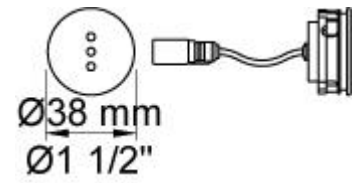
**VR512**

60 mm täckbricka. InnerRadius. 38 mm.

